

Klozets

by Laurysen

Available Klozet Accessories

	<p>Pull-out Rod For clothes hangers to be screwed on the top of the wardrobe.</p>
	<p>Garment Bag Valet For clothes hangers and hanging garment bags. To be screwed on top or bottom of shelf or sidewall of cabinet Consists of: 1 pc. steel sleeve 1 pc. steel rod Finish: sleeve: epoxy-coated or electro-plated rod: electro-plated</p>
	<p>Swing Wardrobe Rail Pivot-able for screw-mounting 180° pivoting range Finish: steel, chrome-plated Mounts: zinc die cast, chrome-plated</p>
	<p>Jewelry Tray Features a single, large compartment and nine small compartments, one of which is specially designed for rings. Dimensions: width x depth x height 584 mm x 356 mm x 50 mm 23" x 14" x 2" Finish: nylon, felt</p>

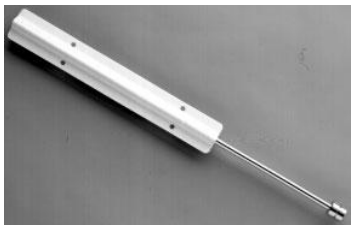
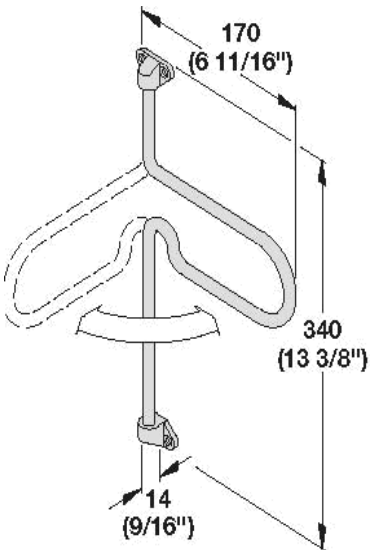
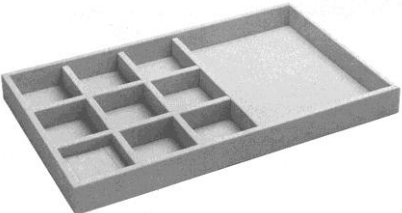

Belt Tray

Features a single, long compartment and four smaller compartments. The 4" depth makes this tray ideal for storing belts, scarves, underwear, socks, and other accessories.

Dimensions: width x depth x height

584 mm x 356 mm x 100 mm

23" x 14" x 4"

Finish: nylon, gray



Valet Tray

Six compartments for storing of coins, wallet, keys, pens, watches, etc.

Dimensions: width x depth x height

312 mm x 185 mm x 64 mm

12 1/4" x 7 1/4" x 2 1/2"

Finish: nylon, felt



Bathroom Tray

Adjustable width and depth.

Dimensions: width x depth

300-340 mm x 220-260 mm

11 13/16"-13 3/8" x 8 5/8"-10 1/4"

Finish: white



Bathroom Tray Divider

Adjustable width.

Dimensions: width x depth

140-527 mm x 454 mm

5 1/2"-20 3/4" x 17 7/8"

Finish: white



Deluxe Iron Board

Built-in ironing centre, electric model. Includes ventilated steel ironing board, hot iron storage compartment, storage shelf, full length piano hinge, ironing board cover and pad, birch veneer cover, spotlight and hook.

Dimensions: width x height

362 mm x 1118 mm

14 1/4" x 46 3/4"



Built-In Iron Board

Centre, non-electric model. Includes ventilated steel ironing board, hot iron storage compartment, storage shelf, full length piano hinge, ironing board cover and pad and birch veneer cover.

Dimensions: width x height

362 mm x 1118 mm

14 1/4" x 46 3/4"



Sleeve Board

For built-in ironing centre.

Dimensions: width x depth x height

127 mm x 57 mm

5" x 2 1/4"



Ironing Board Surface Mounted

Economical wall mounted ironing centre.

Dimensions: width x depth x height

368 mm x 79mm x 1219 mm

14 1/2" x 3 1/8" x 48"



Iron Holder White

White wire iron holder.

Dimensions: width x depth x height

190 mm x 91 mm x 296 mm

7 1/2" x 3 5/8" x 11 3/4"

Finish: white wire



Iron Holder Chrome

Chrome wire iron holder.

Dimensions: width x depth x height

229 mm x 140 mm x 216 mm

9" x 5 1/2" x 8 1/2"

Finish: chrome



Iron Holder Chrome

Chrome wire iron holder.
Dimensions: width x depth x height
229 mm x 140 mm x 216 mm
9" x 5 1/2" x 8 1/2"
Finish: chrome

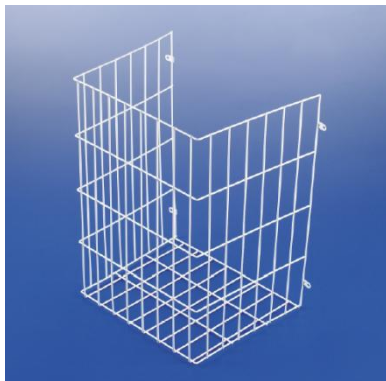

Laundry Hamper

White wire three-sided with mounting brackets.
Dimensions: width x depth x height
300 mm x 240 mm x 400 mm
11 3/4" x 9 1/2" x 15 3/4"



Laundry Hamper

White wire four-sided.
Dimensions: width x depth x height
390 mm x 480 mm x 520 mm
15 3/8" x 18 7/8" x 20 1/2"



Laundry Hamper

Chrome four-sided, Dimensions: width x depth x height
238 mm x 285 mm x 420 mm
9 3/8" x 11" x 17"



Laundry Hamper

White polymer square basket,
Dimensions: width x depth x height
362 mm x 457 mm x 302 mm
14 1/4" x 18" x 11 7/8"



Shoe Fence

For melamine/wooden shelves press-fit in 5 mm diameter drilled holes.
Height: 39 mm (1 1/2")
Finish: steel, chrome-plated



Shoe Holder

For screw-mounting
Extendable from 450 – 800 mm
Finish: steel - chrome-plated
mounting parts - black plastic



Tilt Fitting

For installation in shoe cabinets, 3 sections

Finish: plastic - white



Shoe Rack

Adjustable from 560 – 1000 mm

Finish: rod: steel, black
plastic: black



Folding Step Stool

Folds away for easy storage.

Dimensions: width x depth x height

390 mm x 390 mm x 383 mm

15 9/16" x 15 9/16" x 5 7/16"

Finish: steel: brown, white



Support "Step-Fix" Zinc

Bracket for kick plate for folding step stool.

Folding step stool dimensions with kick plate.

Dimensions: width x height

408 mm x 90 mm

16 1/6" x 3 1/2"

Finish: steel: chrome-plated, steel

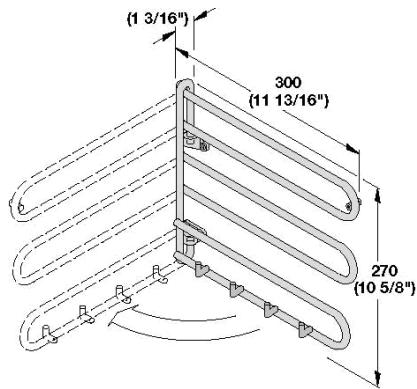

Tie and Belt Holder

Pivot-able for screw-mounting
 90° pivoting range
 Holders are offset
 Finish: steel, chrome-plated
 Mounts: zinc die cast, chrome-plated



Tie and Belt Extension

Complete with glide and spacer.
 Dimensions: 74 x 455 x 118 mm (WxDxH)
 Finish: steel: chrome-plated, polished

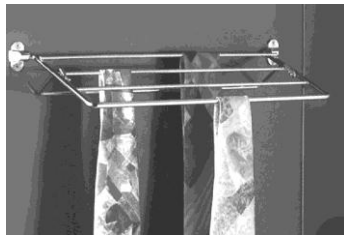

Tie Holder

Foldaway
 Width: 320 mm (12 5/8")
 Depth: 160 mm (6 5/16")
 Height: 25 mm (1")
 Finish: steel: chrome-plated, polished

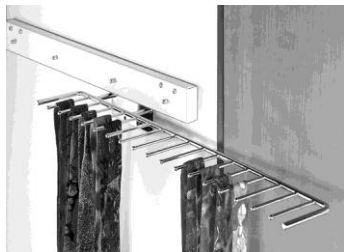

Tie Pull Out

For 17 ties to be used on the left or right
 Width: 130 mm (5 1/8")
 Depth: 540 mm (21 1/4")
 Height: 90 mm (3 9/16")
 Finish: steel: chrome-plated, polished
 Guide-cover: steel plastic-coated, white



Tie Holder

For 32 ties extendable
Length: 500 mm (19 5/8")
Depth: 76 mm (3")
Height: 82 mm (3 1/4")
Finish: aluminum/plastic



Tie Extension Two or Three Armed

Infinitely adjustable, swiveling for left, right or upper mounting.
Finish: steel: chrome-plated, polished

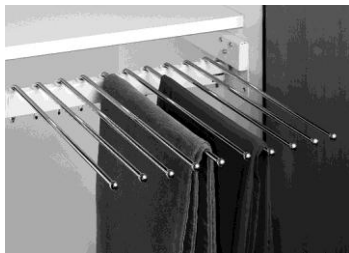

Trousers Extensions

3 armed complete with glide and spacer.
Dimensions: 222 x 455 x 72 mm (WxDxH)
Finish: steel: chrome-plated, polished



Trousers Swivel Pull-out

For 10 pairs of trousers to be used on the left or right.
width: 465 mm (18 5/16")
depth: 505 mm (19 7/8")
height: 100 mm (4")
Finish: steel: chrome-plated, polished
Guide-cover: steel plastic-coated, white



Trousers Holder with Extension Basket

For 7 pairs of trousers, swiveling to be used on the left or right.
Complete with glide and spacer.
Dimensions: 160 x 452 x 194 mm (WxDxH)
Finish: steel: chrome-plated, polished



Wire Basket

For use with optional 547.39 slides
Finish: steel wire, epoxy-coated, white